

Fresa para perfilar

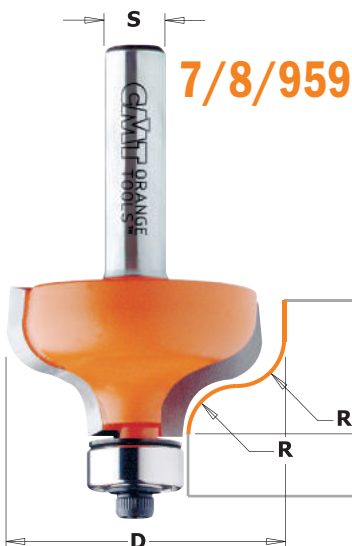

7/8/959

Dé a su tienda una variedad llena de opciones con un surtido completo de fresas para perfilar CMT. Todas las fresas CMT son fabricadas en micrograno de carburo, acero europeo de alta fuerza y nuestra capa naranja de marca registrada.

SUGERENCIAS: Este tipo de trabajo es bastante complejo. Para obtener un mejor resultado es aconsejable realizar más pasadas.

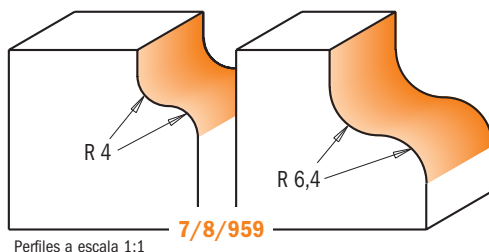



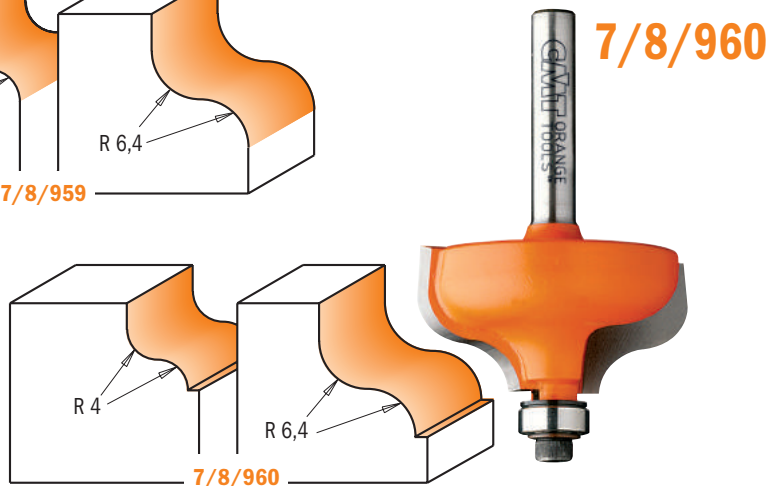

7/8/959

Perfiles a escala 1:1



7/8/960

7/8/960

R mm	D mm	I mm	CÓDIGO					Recambios			
			S=Ø6mm	S=Ø6,35mm	S=Ø8mm	S=Ø12mm	S=Ø12,7mm				
4	28,7	13	759.040.11	859.040.11	959.040.11	959.540.11	859.540.11	990.423.00	791.003.00	990.058.00	991.057.00
6,4	38,1	18	759.064.11	859.064.11	959.064.11	959.564.11	859.564.11	990.423.00	791.003.00	990.058.00	991.057.00
4	28,7	13	760.040.11	860.040.11	960.040.11	960.540.11	860.540.11	990.422.00	791.002.00	990.058.00	991.057.00
6,4	38,1	18	760.064.11	860.064.11	960.064.11	960.564.11	860.564.11	990.422.00	791.002.00	990.058.00	991.057.00