

TARGET

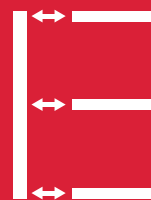

CONNECTINGS

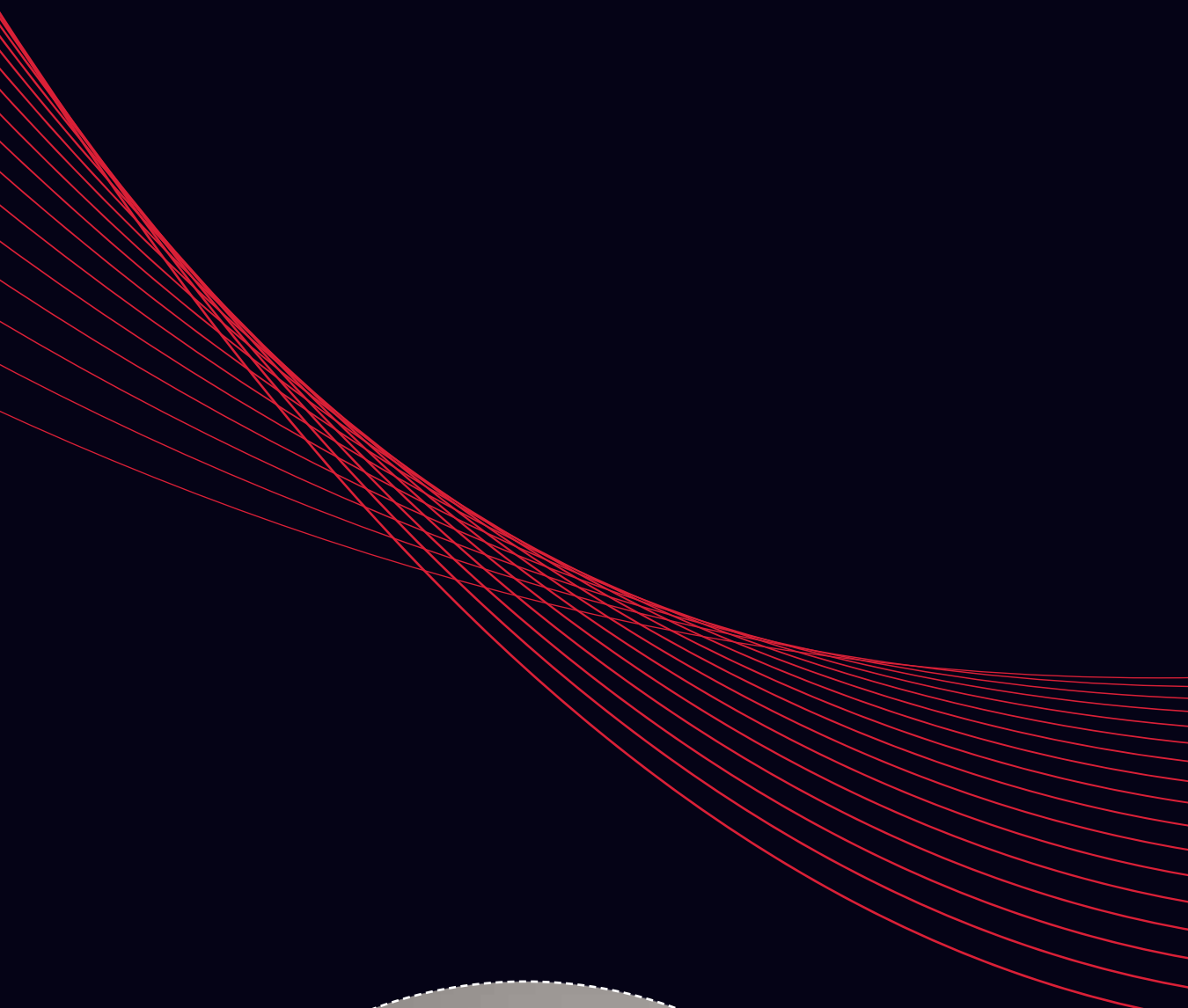



SYMBOLS AND FINISHES LEGEND

SYMBOLS



= SHELF SAFELY LOCKED DURING TRANSPORTATION AND AT HOME.



= ANTI-TURNOVER LOCKING SYSTEM



= NORMS / PATENTS



= PHILLIPS / POZIDRIV



= NEWTON



= PART.NO



= HEXAGONAL SOCKET



= FRICTION



= PCS. PER PACKAGE



= BLADE SLOT



= AUTOMATIC



= COMBI SLOT



= DROP DOWN



= CAPACITY LOADING



= COUNTERSUNK HEAD



= WOOD / GLASS THICKNESS



= PAN HEAD



= STANDARD HINGE



= HOLE DIAMETER



= FLANGE HEAD



= KIMANA HINGE



= DIAMETER



= FLAT HEAD



= FLAP HINGE



= LENGTH



= TRILOBULAR SCREW



= WITH SPRING



= HEIGHT



= SELF-TAPPING SCREW



= WITHOUT SPRING



= RIGHT VERSION



= EURO THREAD



= REVERSED SPRING



= LEFT VERSION



= METRIC THREAD



= SETTING CODE



= PRE-INSERTED SCREW



= FOR ROUND TUBE



= PCS. PER PAD



= PRE-INSERTED SCREW AND SPREADING BUSH



= FOR OVAL TUBE



= CUT ON REQUEST



= WITH BUFFER



= SELF ADHESIVE



= WITH MAGNET



= WITH FLANGE

NOTE: Printing errors and omissions may exist despite our best efforts to ensure accuracy. We reserve the right to alter specifications without notice.

MATERIALS

| | | | | |
|--|---------------------------------|-------------------------------|-------------------|--|
| ZA = Zinc Alloy | ST = Steel | HSS = High Speed Steel | BR = Brass | ABS = Acrylonitrile Butadiene Styrene |
| ZAnk = Nickel-plated Zinc Alloy | STzk = Zinc-plated Steel | AL = Aluminium | WD = Wood | EVA = Ethylene Vinyl Acetate |

EP = **ENGINEERING PLASTIC**

+ **EP** = other engineering plastic available on request

SR = **SOFT RUBBER**

+ **SR** = other soft rubber available on request

EPn = Natural Engineering Plastic

EPc = Clear Engineering Plastic

SRn = Natural Soft Rubber

EPw = White Engineering Plastic

EPg = Grey Engineering Plastic

SRw = White Soft Rubber

EPwg = Water Green Engineering Plastic

SRb = Black Soft Rubber



FINISHES



= OTHER FINISHES AVAILABLE ON REQUEST

| | | | | | |
|----|---------------|----|--------------------------|----|------------------------------|
| AA | Natural | JB | Bright Aluminium | QB | Walnut |
| AB | White | JC | Aluminium - Chrome | RO | Red |
| AC | Opal White | JD | Matt Aluminium | UZ | T -Met |
| AE | White 9010 | JE | Satin-finished Aluminium | WA | Bronzed |
| AK | Champagne | JF | Aluminium - Brass | WI | Burnished |
| AL | Ivory | JG | Aluminium 5 | XD | Satin-finished Steel |
| EA | Black | JL | Aluminium PE 11 | YA | Nickel-plated |
| EB | Glossy Black | JM | Aluminium RAL 9006 | YB | Bright Nickel-plated |
| EC | Matt Black | KA | Chrome | YC | Matt Nickel-plated |
| EE | Anthracite | KB | Bright Chrome | YD | Satin-finished Nickel-plated |
| FU | Gunmetal | KC | Matt Chrome | ZA | Zinc alloy |
| GR | Raw | MA | Brown | ZN | Zinc-plated |
| HA | Brass-Plated | MB | Light Brown 1 | ZQ | Bright Gold |
| HH | Tropicalized | NN | Metallic Beige | ZY | Titanium |
| HL | Raw Brass | NO | Beige | ZZ | Clear |
| IA | Grey | OA | Oak | 00 | Insignificant finish |
| IB | Metallic Grey | OZ | Ash | | |
| IF | Middle Grey | PA | Light Ash | | |
| IJ | Light Grey | PZ | Beech | | |
| IL | Grey 20 | QA | Maple | | |

TARGET J10

TARGET is the new structural connecting fitting conceived by Italiana Ferramenta with high fastening capacity, suitable for mounting with wood dowels.

TARGET is an ideal solution for the installation of cabinets in tight spaces.

TARGET provides the possibility of pre-assembling into the panels without obstructing the packaging.

FEATURES AND BENEFITS

Easy pre-assembling

Simple pre-insertion into the panels. Conceived for automatic assembling.

Suitable for furniture in kit

Its unique features make **TARGET** the ideal solution for kit furniture.

No hardware kits

There is no need of hardware kits.

High-speed assembling

Mounting is extremely fast and efficient thanks to the pre-assembling of the panels.

Strong structural fastening

The panels are hard and securely fastened, therefore the cabinet is 100% stress-resistant.

Wide range of applications

Practical solution for a wide range of applications.

Interzum Award:
Intelligent material & design 2017

High Product Quality



15 - 25 mm



INSTALLATION

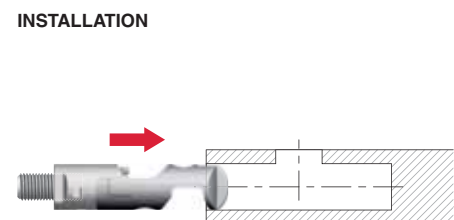

VERY IMPORTANT

Insert **TARGET** connecting with countersunk hole on top.

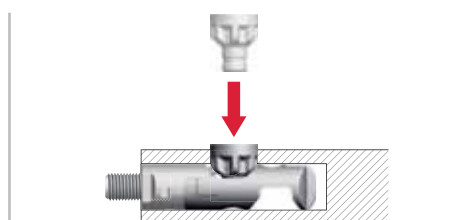
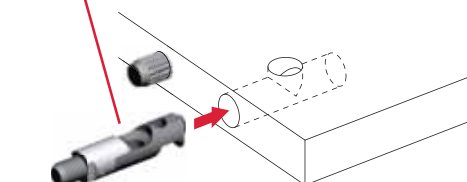

Place the pinion screw from above.

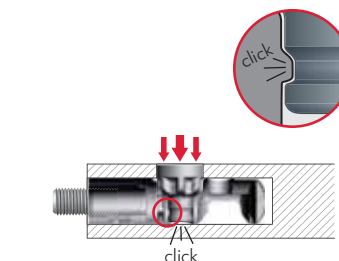
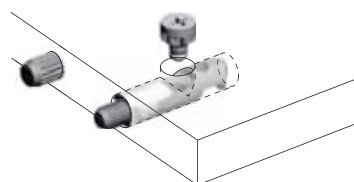

Press strongly with P22 cross screwdriver to slot the pinion screw in.

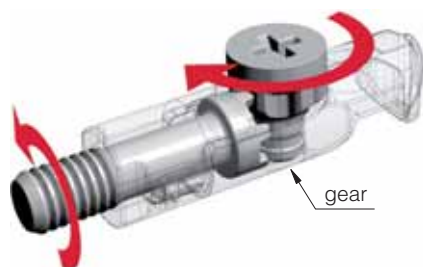
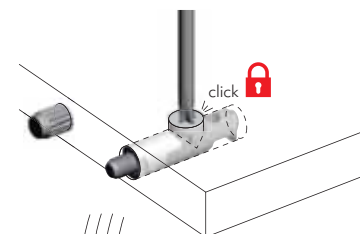

By turning the pinion screw, the threaded dowel makes a synchronized rotation.

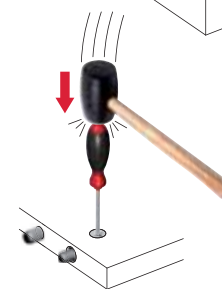

It may be helpful to use a tool in order to easily slot the pinion screw in.

ASSEMBLING

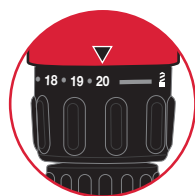

VERY IMPORTANT

It is allowed to use a cordless driver drill **ONLY** with **friction mode** on.

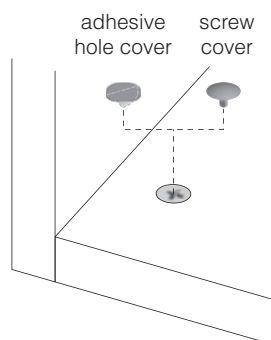
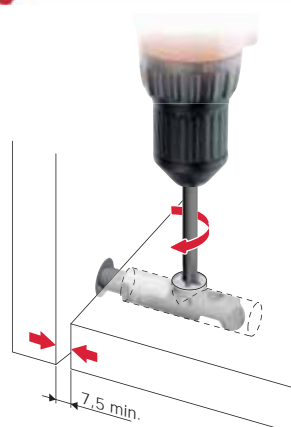



TARGET J10

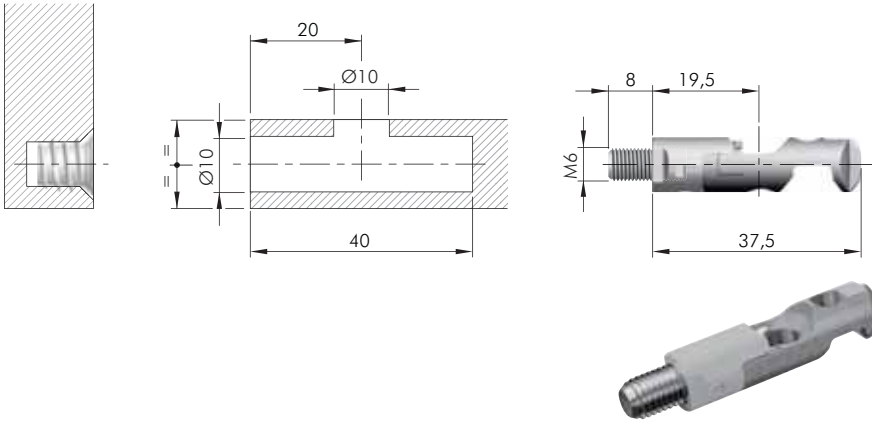

= M6
 ZA ST EP = 1000 pcs.
 123
 21802160Z**N**

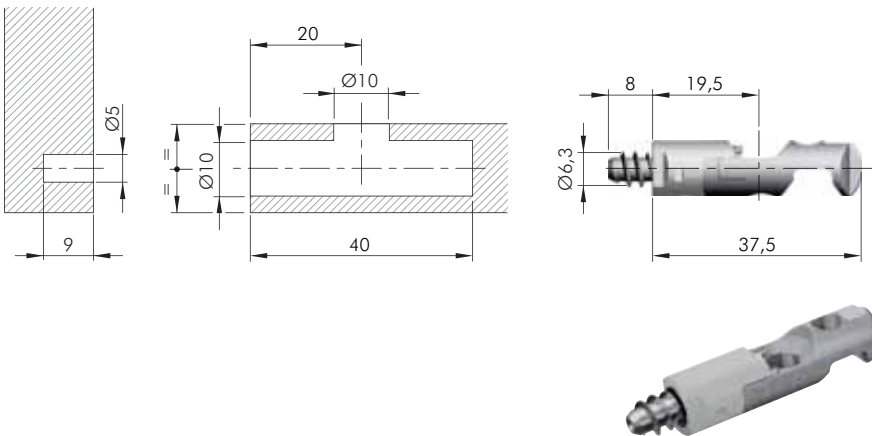

ZA ST EP = 1000 pcs.
 123
 21803160Z**N**

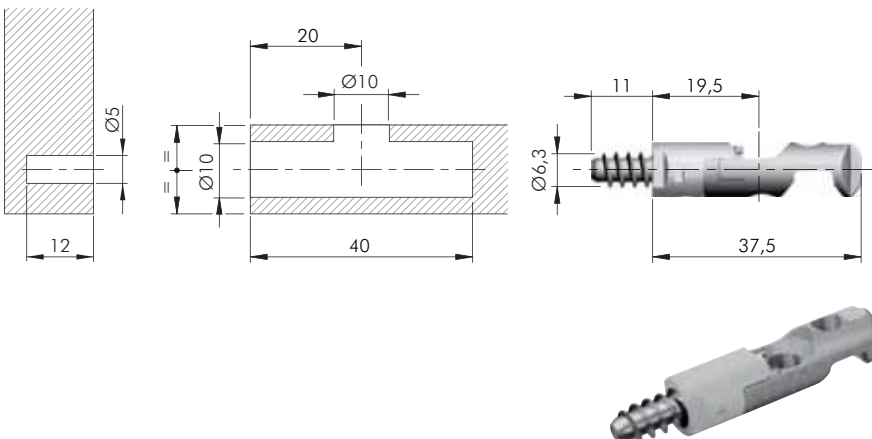

ZA ST EP = 1000 pcs.
 123
 21803220Z**N**

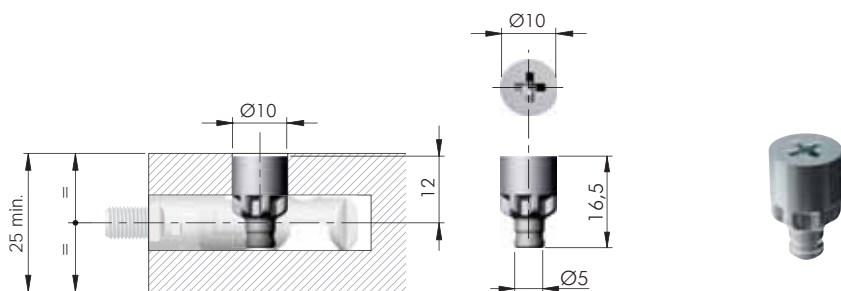
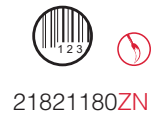
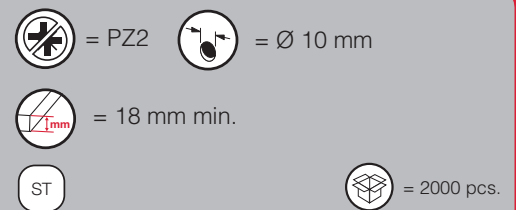
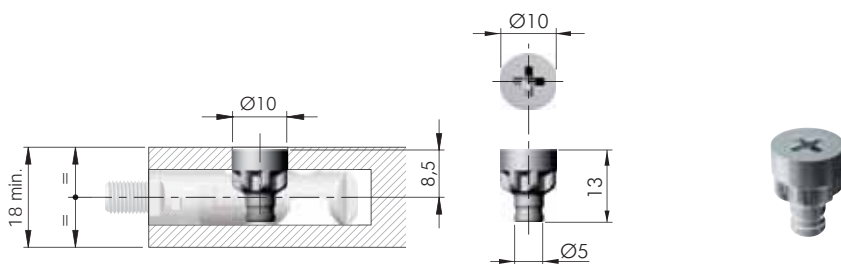
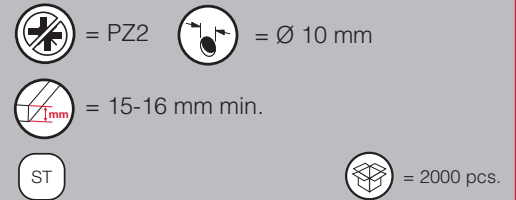
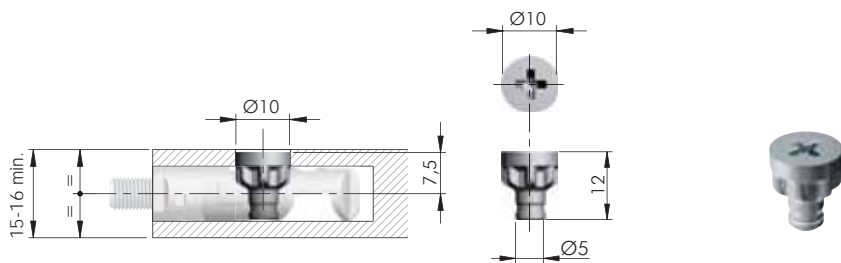



M6 thread

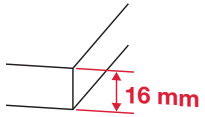

Euro thread

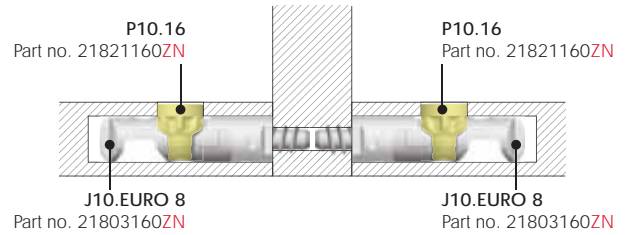
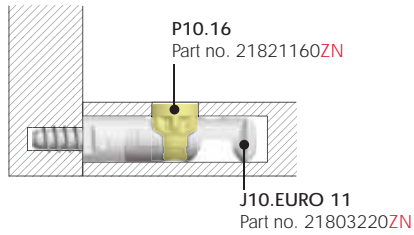
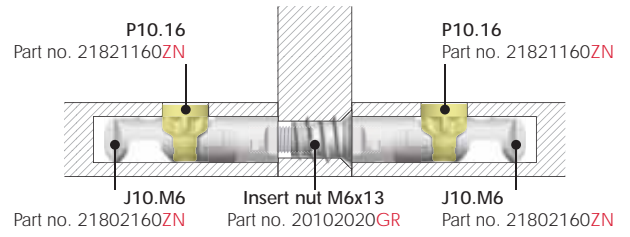
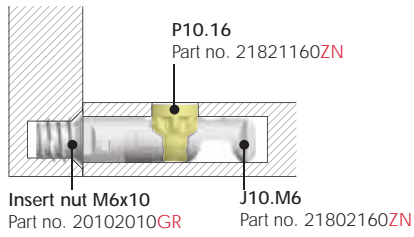

M6 thread

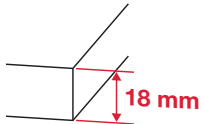

Euro thread

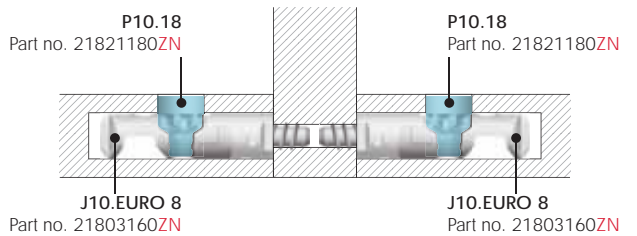
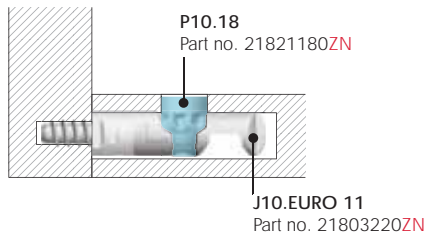
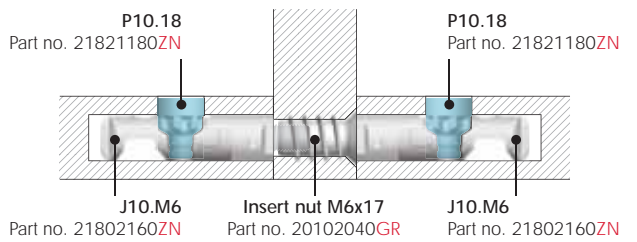
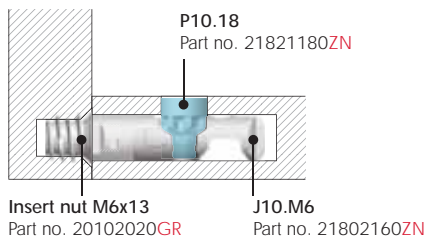

M6 thread

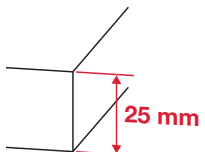



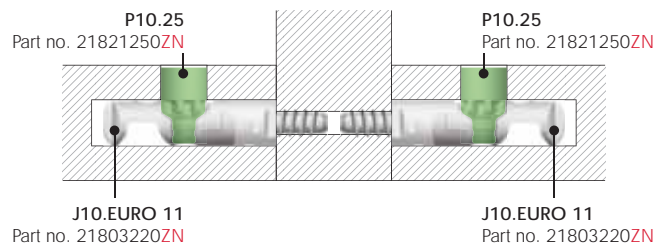
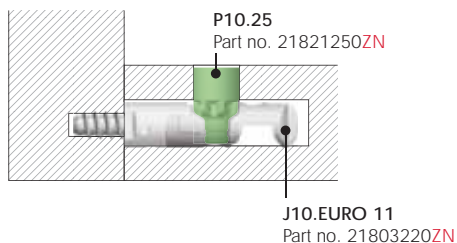
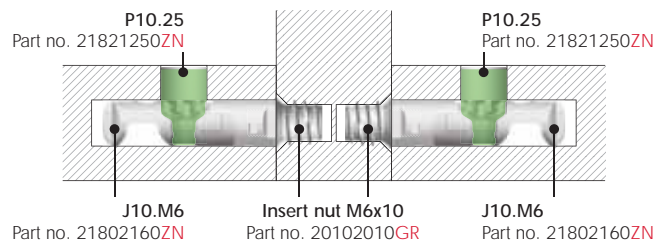
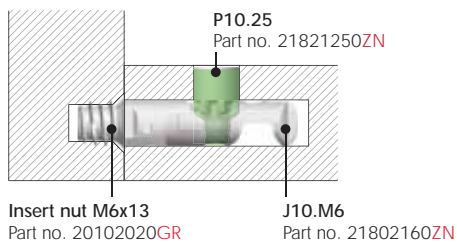

Euro thread

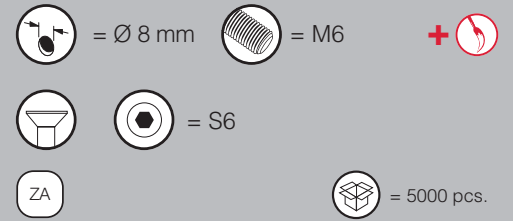
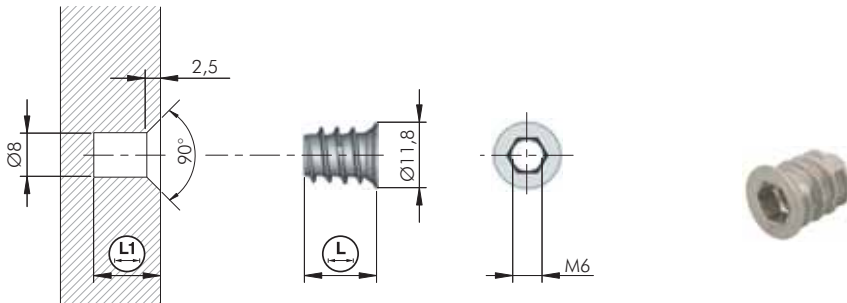

TARGET FIXING ACCESSORIES





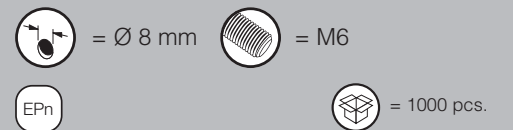
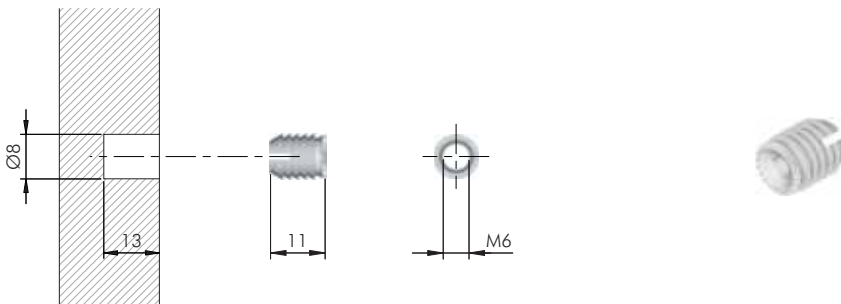

|  123  |  |  |
|---|---|---|
| 20102010GR | 10 | 12 |
| 20102020GR | 13 | 15 |
| 20102040GR | 17 | 19 |

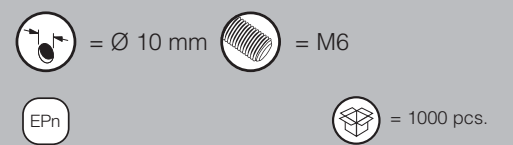
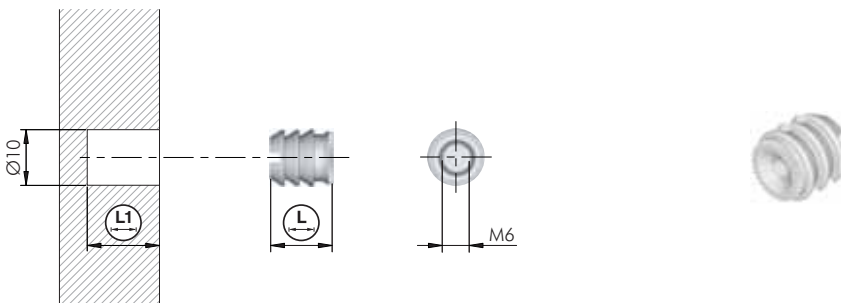

|  123  |
|---|
| 20303030AA |



|  123  |  |  |
|---|---|---|
| 20304030AA | 11 | 13 |
| 20304040AA | 13 | 15 |



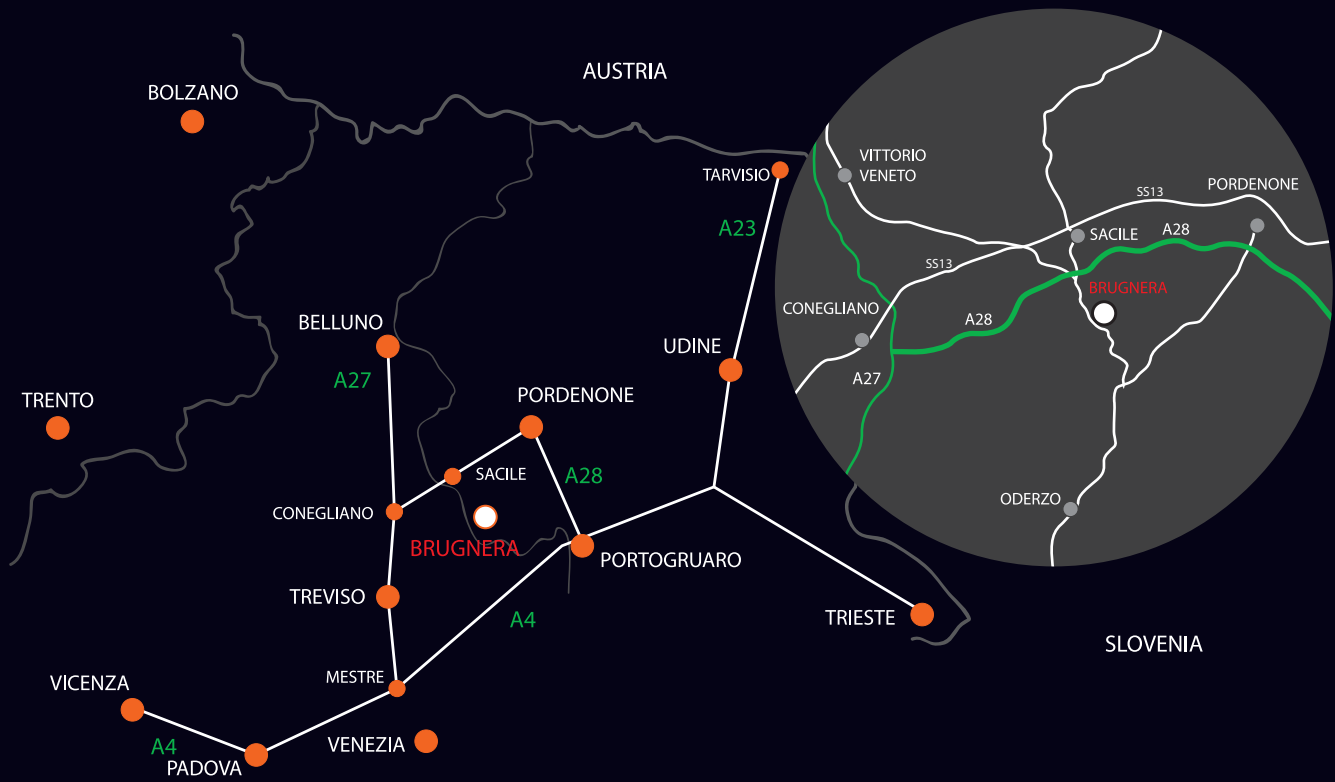

www.italianaferramenta.com